

# KAISAI

KHY-12PY3

KHY-15PY3



**WE  
CARE  
ABOUT  
AIR**

**USER MANUAL**

**HEAT PUMP AIR-TO-WATER R290**

EN



**KAISAI**

# **HEAT PUMP AIR-TO-WATER**

KHY-12PY3

KHY-15PY3

## **User Manual**

Thank you for choosing our product.

To ensure proper operation, please read the manual and keep it for future reference.

# Contents

<b>1. Introduction .....</b>	<b>5</b>
<b>2. Safety instructions.....</b>	<b>6</b>
<b>3. Features of the device.....</b>	<b>8</b>
<b>4. Functions .....</b>	<b>9</b>
4.1. Advanced control .....	9
4.2. Modern design .....	9
4.3. Easy installation .....	9
4.4. Quiet operation .....	9
4.5. High heat exchange coefficient.....	9
4.6. Wide operating range.....	9
<b>5. Maintenance .....</b>	<b>10</b>
<b>6. Inspection .....</b>	<b>10</b>
6.1. Preparation for Inspection and Maintenance .....	10
6.2. Product Cleaning.....	11
<b>7. Accessories .....</b>	<b>11</b>
7.1. Accessories included with the unit .....	11
<b>8. Precautions .....</b>	<b>12</b>
8.1. Before Installation .....	12
8.2. Handling and Transportation .....	12
<b>9. Operation and Inspection.....</b>	<b>12</b>
9.1. Display Interface Description .....	12
<b>10. The functions of the Domestic Hot Water (DHW) .....</b>	<b>19</b>
<b>11. 3-way cooling valve.....</b>	<b>21</b>
<b>12. SG Ready.....</b>	<b>21</b>
12.1. Schematic of the mainboard .....	21
12.2. Smart Grid Ready=1.....	21
12.3. Smart Grid Ready=2.....	22
12.4. Parameters .....	26
<b>13. Add multi-zone control function.....</b>	<b>30</b>
13.1. Application .....	30
13.2. Zone control .....	32
13.3. Various Zone Options.....	36
13.4. Setting the Target Temperature for Zone 1 .....	38
13.5. Setting the Target Temperature for Zone 2.....	40
13.6. Setting temperature for zone control in cooling mode.....	42
13.7. Zone Control Function Parameters .....	42
13.8. Parameters .....	43
<b>14. Muting .....</b>	<b>45</b>
<b>15. Curve .....</b>	<b>45</b>
<b>16. Failure.....</b>	<b>46</b>



# 1. Introduction

To ensure high quality and reliability for our customers, this heat pump is manufactured according to strict design and production standards. This manual contains all the necessary information regarding maintenance. Please read this manual carefully before opening or performing maintenance on the device.

The manufacturer of this product is not liable for any injuries or damages that may occur as a result of improper installation, assembly, or maintenance that is not in accordance with this user manual.

**The device must be installed by a qualified installer. The condition for granting warranty for the device is installation in accordance with Technical and Operation Documentation guidelines and commissioning of the device by an authorized service partner.**

To maintain the warranty, it is essential to always adhere to the provisions of this manual and the Technical documentation instructions.

- Only a qualified installer or an authorized dealer is permitted to open or repair the device.
- Maintenance and servicing should be carried out according to the recommended schedule and frequency as provided in this instruction manual.
- Use only original, standard replacement parts.

**Failure to comply with these recommendations will result in the warranty being voided.**



The air-to-water inverter heat pump is a type of high-efficiency, energy-saving, and environmentally friendly device mainly used for heating homes. It can work in conjunction with various heat emitters such as fan coils, radiators, or underfloor heating systems, providing hot water for domestic use as well. One external unit of the monoblock heat pump can also cooperate with multiple indoor units simultaneously.

The heat pump is designed to provide heat for heating purposes and to produce domestic hot water





## 2. Safety instructions

To protect users and service personnel from injuries, prevent damage to the equipment or other property, and ensure proper operation of the heat pump, it is essential to carefully read and thoroughly understand the information provided in this instruction manual. It is forbidden to use the device incompatibly with its intended purpose.



### Description of the Labeling



Labeling	Meaning
 WARNING	Improper actions can lead to death or serious injuries.
 CAUTION	Improper operation can lead to injury or health loss.



### Description of Icons

Icons	Meaning
	Forbidden. The icon indicates actions that are prohibited or not allowed.
	Mandatory actions. The icon indicates tasks or actions that must be performed as described
	Caution (including Warning). Please pay attention to what is indicated.
	Fire Hazard / Flammable Materials.
	No Open Flame Allowed.



## Warning



Operation	Meaning
 Prohibition	Do not insert fingers or other objects into the fan and evaporator of the device; otherwise, damage may occur.
 Power off	In case of unusual operation or odors, disconnect the power to stop the device. Continuing operation may result in electrical short-circuits or fire.



Move and Repair	Meaning
 Suggested	In case of the need for reinstallation or restarting the heat pump, it is recommended to have it done by qualified personnel. Improper installation may lead to water leaks, electric shock, injuries, or fire.
 Suggested	Self-repair of the device is prohibited; otherwise, it may result in electric shock or fire.
 Prohibition	When the heat pump requires repair, it must be performed by qualified personnel. Improper handling or repair of the device may result in water leakage, electric shock, injuries, or fire.

	Do not use any defrosting or cleaning agents other than those recommended by the manufacturer.
	The device should be stored in a room and installed in an environment without a constant or potential source of ignition (e.g., open flame, operating gas appliance, operating electric heater, electrical sparks, or hot objects).

## Caution

Installation	Meaning
 Installation Location	The device must not be installed near flammable gas. In case of a gas leak, it may cause a fire.
 Repair of the device	Ensure that the heat pump substructure is strong enough to prevent tipping or device falling.
 You need a switch	Ensure that the device is equipped with an automatic power switch; the absence of the switch may lead to electric shock or fire.

Icons	Meaning
 Check the foundation structure.	We kindly request regular inspection of the installation substructure (once a month) to avoid tipping or damaging the substructure, which may cause harm to people or the equipment.
 Power off	Turn off the power during cleaning or maintenance.

 Prohibition	Using copper or steel inserts as fuse is prohibited. A proper fuse must be installed by authorized electricians.
 Prohibition	Spraying flammable gas on the heat pump is prohibited, as it may cause a fire.

## 3. Features of the device

- Plate heat exchanger: An efficient SWEP heat exchanger with small dimensions and high efficiency is used.
- The device is delivered ready for operation and is filled with the refrigerant R290.

- A new generation of environmentally friendly refrigerant R290 has been used, which is harmless to the ozone layer.
- Heating in low outdoor temperatures: With a well-optimized installation, the device is designed to perform optimal heating even in low temperatures.
- **To ensure full heat demand coverage and ensure energy security for the building in case of device failure, the installation of a backup heat source in the form of an electric heater with power specified in Installation manual is required. This is a necessary condition to maintain the warranty.**
- The KHY series heat pumps come equipped with a factory-installed communication module (DTU). The module is used to read device operating parameters, enabling the manufacturer to improve their product, enhance customer satisfaction, and achieve maximum device efficiency in specific climates. The module does not record any sensitive data, such as detailed locations. The data collected by the module is stored by an external entity. Klima-Therm does not gather data obtained by the DTU module. Additionally, Klima-Therm does not provide any application for remote control of the device using the DTU module, and thus, it assumes no responsibility for customers creating accounts in applications provided by external entities, their operations, or data collection.  
The use of applications that support the DTU module is at the user's own risk, and Klima-Therm disclaims any responsibility for such actions.
- Klima-Therm does not provide any technical support for applications from external providers that support the DTU module.



**The refrigerant R290 is flammable and explosive. It is prohibited to install it in environment where there are operating or potential sources of ignition**

## 4. Functions

This series of heat pumps has the following features:

### 4.1. Advanced control

The microcomputer-based controller allows users to view and adjust the heat pump's operating parameters. Possibility to control the cascade system through an external additional controller.

### 4.2. Modern design

The heat pump has been meticulously designed with attention to aesthetic appearance, ergonomics, and user-friendly operation.

### 4.3. Easy installation.

The unit features an ergonomic design with compact casing and is easy to install outdoors.

### 4.4. Quiet operation

The heat pump unit utilizes a specially designed fan to minimize noise emissions.

### 4.5. High heat exchange coefficient.

The heat pump unit utilizes a specially designed heat exchanger to enhance overall efficiency.

### 4.6. Wide operating range.

This series of heat pumps is designed to operate in various temperature conditions.

## 5. Maintenance

Before the initial device startup or after a prolonged pause, the following preparations should be performed

1. Thoroughly inspect and clean the device
2. Clean the water system – mesh filter.
3. Check the water pump, regulating valve, and other water system components
4. Tighten all pipe connections

### **Do not change system parameters before consulting with engineer**

Ensure that the water supply and drainage device is functioning correctly; otherwise, the efficiency and reliability of the device may be compromised.

Ensure that water installations are clean and avoid dirt and blockages.

Check the current, water, and replace faulty parts at appropriate intervals.  
Please use parts supplied or recommended by the manufacturer; do not use non-original parts.

If you need to replenish refrigerant due to a leak, contact the service or the sellers.

### **Periodic maintenance (every 12 months).**

To ensure proper operation of the device and maintain the warranty, arrange inspection by an authorized Service Partner before 12 months of commissioning.

## 6. Inspection

### **6.1. Preparation for Inspection and Maintenance**



#### **Zagrożenie!**

Risk of death due to fire or explosion in case of refrigerant leakage!









- Perform tasks only when you are competent and have knowledge of the special properties and hazards associated with refrigerant R290.
- The product contains flammable refrigerant R290. In the event of a leak, the released refrigerant may mix with air, creating a flammable atmosphere.
- There is a risk of fire and explosion.
- Ensure that the space around the device is adequately ventilated
- Before engaging in inspection, maintenance, or replacement of parts, adhere to safety principles
- Disconnect the device from power and ensure that the product is correctly grounded.

## 6.2. Product Cleaning

- Do not clean the product with a high-pressure washer or direct water stream
- Clean the product with water and a cleaning agent
- Do not use abrasive cleaning agents. Do not use solvents. Do not use cleaning agents containing chlorine or ammonia.
- Check for dirt between the fins of the heat exchanger or if settlements cling to lamellae
- Clean the lamellae using a soft brush, avoiding bending the exchanger fins
- Check if dirt has accumulated in the condensate drip tray or in the drain pipe
- Check if water is not pooling in the tray and can flow freely

## 7. Accessories.

### 7.1. Accessories included with the unit.

Components		
Names of Elements	Symbol	Quantity
User Manual		1
Vibration dampers		4
Screws		4
Signal cable		1
Wired control panel		1
Temperature sensor		1
Condensate drain		1
Energy labeling		1

## 8. Precautions

### 8.1. Before Installation

Check the model name and serial number of the unit. It is required to read the installation manual and technical documentation.

### 8.2. Handling and Transportation

Due to the relatively large dimensions and weight of the unit, it can only be moved using lifting equipment with slings. The slings can be mounted on sleeves on the base frame arms specifically designed for handling.

 <b>Caution</b>
To avoid damage, do not touch the air inlet or the aluminum exchanger fins of the unit
Do not use clamps on the ventilation grilles to avoid damaging the units
The unit is heavy! Prevent the device from falling due to improper tilting during transportation

## 9. Operation and Inspection





### 9.1. Display Interface Description

#### 9.1.1. Mode Selection Interface







Marking	Key Functions
	<p>Power On/Off Button: When the button is displayed in blue, it indicates the power-on state. Upon touching, it will change color to white and switch to the power-off state</p>
	<p>Screen Lock Button: You can perform various operations on the display when the lock is open, but you cannot operate the display when the lock is closed. After locking the screen, press the screen lock button and enter the password '22' to unlock the screen</p>
	<p>It displays the current date, time, and day of the week</p>
	<p>Ambient Temperature: Display the current ambient temperature</p>
	<p>Timer On/Off Function Icon: This icon will be displayed when the timer on/off function is activated</p>
	<p>Timer Mute Function Icon: This icon will be displayed when the timer mute function is activated</p>
	<p>Enter Defrost Icon: This icon will be displayed when the unit enters the defrosting function</p>
	<p>Fault Icon: This icon will be displayed in case of a device malfunction</p>
	<p>Operating Mode Icon indicates that the device is currently operating in the heating + hot water mode. There are five available modes: heating, cooling, hot water, hot water + cooling, hot water + heating</p>
	<p>Operating Mode Icon indicating that the device is currently operating in the heating mode</p>

Marking	Key Functions
	<p>Operating Mode Icon indicating that the device is currently operating in the cooling mode.</p>
	<p>Operating Mode Icon indicating that the device is currently operating in the cooling + hot water mode.</p>
	<p>Operating Mode Icon indicating that the device is currently operating in the hot water mode.</p>
<p><b>Mode</b></p>	<p>Mode Selection Button: Upon touching the button, the device will enter the mode selection interface, allowing you to set the mode.</p>
<p><b>45.5°C</b></p>	<p>The target temperature refers to the desired temperature value corresponding to the current mode.</p>
<p><b>Target</b></p>	<p>Target Temperature Setting Button: Upon touching the button, the device will enter the target temperature setting interface, allowing you to set the target temperature for the current mode.</p>
<p><b>24.5°C</b></p>	<p>The outlet water temperature, which refers to the current temperature of the water exiting the device.</p>
<p><b>DHW 35.7°C</b></p>	<p>The tank temperature, which refers to the current temperature of the water in the hot water tank</p>
	<p>The main interface icon, indicating that the current page is the main interface. Swipe left to enter the 'Function Settings Interface'; Swipe right to enter the 'Main Status Interface'.</p>

## 9.1.2. Mode Selection Interface

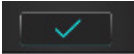

Marking	Key functions
<b>DHW+Heating</b>	Mode selection element, which will be highlighted after selection, indicating that the currently set mode is domestic hot water (DHW)+heating.
<b>Heating</b>	Mode selection position, which will be highlighted after selection, indicating that the currently set mode is heating
<b>Cooling</b>	Mode selection position, which will be highlighted after selection, indicating that the currently set mode is cooling
<b>DHW+Cooling</b>	Mode selection position, which will be highlighted after selection, indicating that the currently set mode is DHW+cooling.
<b>DHW</b>	Mode selection position, which will be highlighted after selection, indicating that the currently set mode is hot water.
	Confirmation button, which can be pressed to save the selected content.
	Back button, which can be pressed to return to the main interface without saving the selected content



## Mode selection operation:

Click the "Mode selection button" on the main interface to enter the "Mode selection interface," and then slide the "Mode selection element" to highlight the selected mode. Press the "Confirm" button to save and confirm, thus completing the mode selection operation. If you press the "Back" button, the system will return to the main interface without saving the settings.

### 9.1.3. Function settings interface

In the main interface, swipe left to access the "Function settings interface."

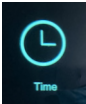
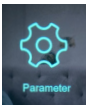



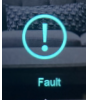
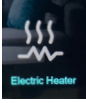
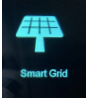

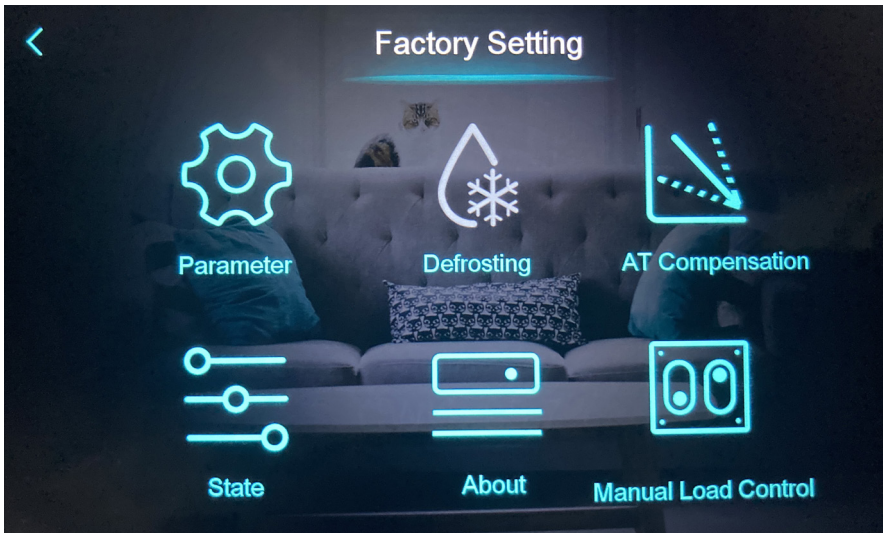

Marking	Key functions
	Time function button: Tap to access the "Time function settings interface," where you can set the system time, configure the timer on/off, and enable the timer mute function (H22=1).
	Function settings button: You must enter a password to access the relevant function settings interface.
	Curve function button: Allows recording temperature changes from the last hours of operation.

Marking	Key functions
	System brightness button: Allows adjusting the display brightness.
	Error display function button: Enables displaying information about faults or errors.
	Quick heating function button: This button allows for rapid heating with a single touch. The icon is displayed only when R35≠0.
	Programmer for mode, temperature, and Smart Grid power: This feature allows you to set schedules for different modes, desired temperatures, and power levels based on the Smart Grid signal.

#### 9.1.4. Interface for customer function

In the "Function Settings Interface," tap the "Parameter" The "Password Input Interface" will appear. Enter the password "22" and press the "Confirmation Button" to access the "Factory Setting Interface".





Marking	Key functions
	<p>Customer Parameter Button: Tap to enter the “Customer Parameter Interface,” which displays the parameters that can be configured.</p>
	<p>Manual Defrost Button: Tap to enter the manual defrost function.</p>
	<p>Ambient Temperature Compensation Curve Setting Button: Tap to enter the ambient temperature compensation curve setting interface.</p>
	<p>Unit Status Button: Tap to enter the “Device Status Interface,” where the operational states (on/off) of individual installation components are visible.</p>
	<p>Unit Information Button: Tap to enter the “About Interface,” where you can view essential information about the device and software.</p>
	<p>Return Button: Tap to go back to the “Function Settings Interface.”</p>

### 9.1.5. Time Function Settings Interface

In the “Function Settings Interface,” touch the “Time Function Button” to enter the “Time Function Settings Interface.” Here, you can set the system time, configure the timer switch, and enable the timer mute function and configure hot water circulation pump, if it has been connected.

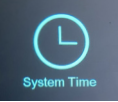

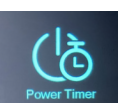
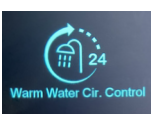
Marking	Key functions
	System Time Setting Button: Allows you to set the system time.
	Mute Timer Button: When the device has a mute function, this button allows you to enable time-based control for that function.
	Power On/Off Timer Button: This button enables time-based control for turning the device's power on/off.
	Warm Water Cir. Control. This function allows you to configure the operation of the circulation pump (if connected)

## 10. The functions of the Domestic Hot Water (DHW)

Depending on the connections made to the following pins on the main board, it is possible to control additional components such as the circulation pump for hot water. In the system parameters, parameter H40 should be configured according to the following assumptions.

- 0 – hot water pump
- 1 – the circulation pump for hot water.
- 2 – Off signal during defrosting.

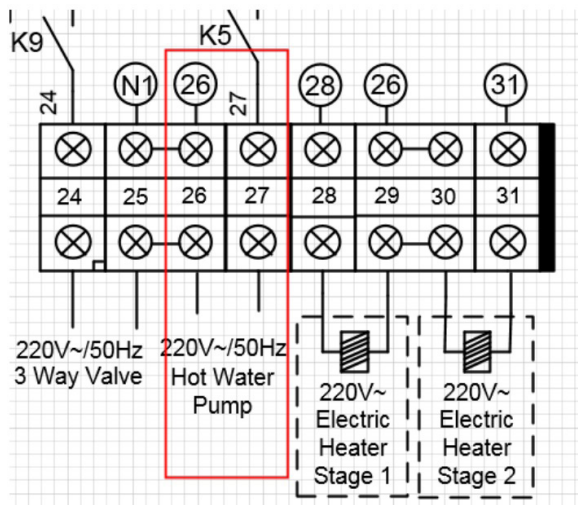

0 – Charging pump for domestic hot water tank. Pump used in the case of an additional heat exchanger between the unit and the DHW tank, separating the circuits.

1– Circulation pump for domestic hot water - After turning on the tap with hot water in the bathroom or kitchen sink, the user expects immediate delivery of hot water. The circulation pump maintains the flow of hot water throughout the water installation, making it instantly available at all taps. If the user requires continuous access to hot water, option 1 can be selected and this pump can be connected to the heat pump.

There are a total of 3 available time settings, and the operational logic and interface are identical to the on/off timer.

ON:

After setting the desired time, the signal from the hot water circulation pump port will be transmitted to the hot water circulation pump.

Screenshot

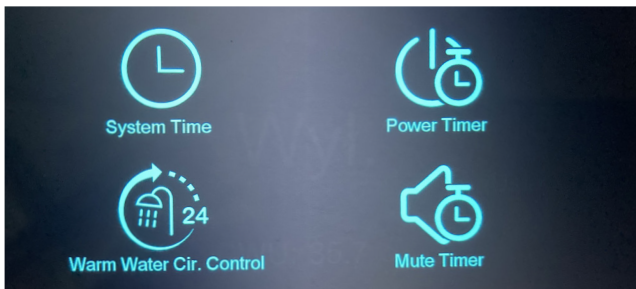
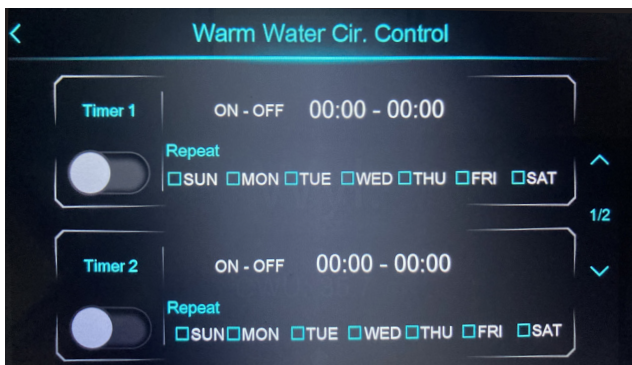

2– Off signal during defrosting - in winter, some users wish to turn off the water pump from the buffer tank so that only the heat from the buffer tank is used for defrosting.



# 11. 3-way cooling valve

Use the RO12 port as the output port for the 3-way cooling valve

Logic:

In heating or hot water mode, OFF signal is sent. In cooling mode, ON signal is sent

# 12. SG Ready

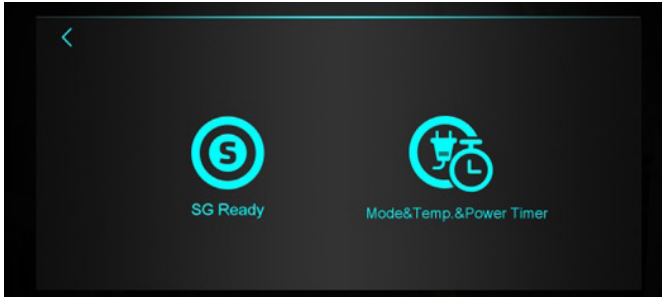

## 12.1. Schematic of the mainboard

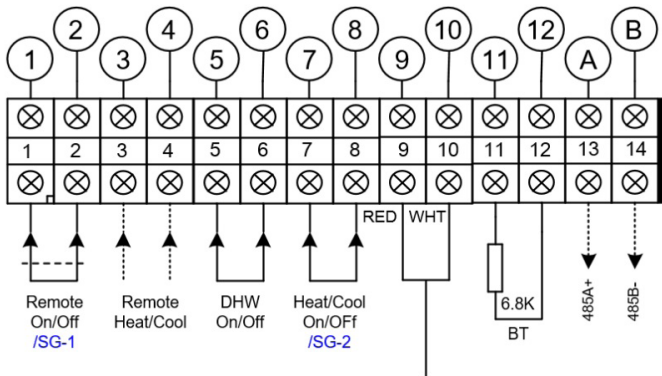

## 12.2. Smart Grid Ready=1

Utilization of a single potential-free contact:

SG-2	Smart Grid Ready=1
Open	Normal mode
Closed	Mode 4

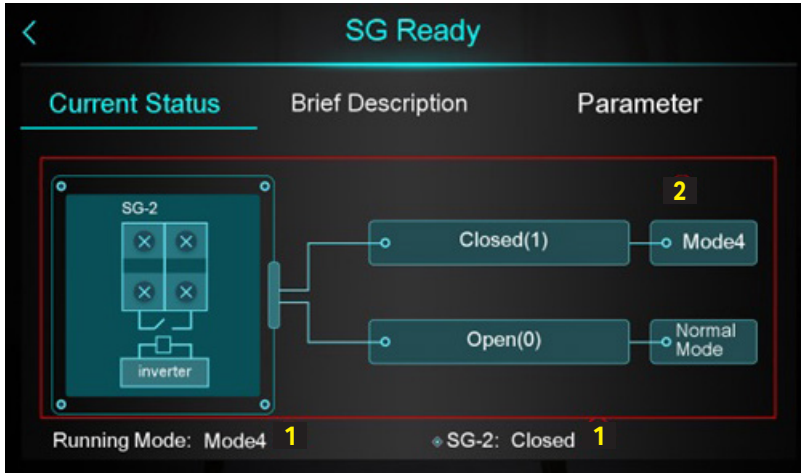

1	Displays the current status
2	Illustration serving as an explanation

**Caution:**

SG-1 is the emergency switch port, and SG-2 is the port for connecting the PV (Photovoltaic). In normal mode, enabling the electric heater is not allowed.

**12.3. Smart Grid Ready=2**

Utilization of two potential-free contacts:

SG-1	SG-2	Smart Grid Ready=2
Closed	Open	MODE-1
Open	Open	MODE-2
Open	Closed	MODE-3
Closed	Closed	MODE-4

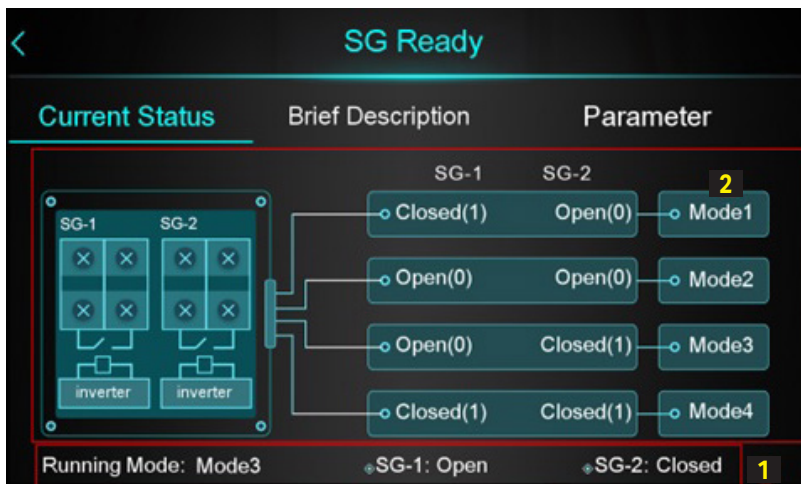

1	Displays the current status.
2	Illustration serving as an explanation.

### 1. MODE 1: Solar Sleep Mode

Only works when the heat pump is on, during sleep mode, the heat pump is in standby mode (the action is the same as the unit turns off after reaching the target temperature), the anti-freeze protection function can still work at this time.

It is a sleeping cycle from the time it enters sleeping mode to the time it exits this mode.

Each time the unit reaches the target temperature and shuts down, it can get one chance to enter the MODE 1, the chance is capped at 1, (The unit can only enter the sleep cycle once no matter how many times the unit shuts down after reaching the target temperature.), therefore, there is only one chance to enter the sleep cycle at most after the water temperature drops and the turns on, after the unit goes into sleep mode and consumes this chance, it is required to continue working until after the unit shuts down to regain a chance that can enter the MODE 1.

During the unit in standby state, if MODE1 is triggered, the heat pump does not enter the MODE1 or consume the times of MODE1. And if the heat pump can maintain this state from standby to will start, the heat pump will enter the MODE1 immediately and consume this chance to enter MODE1.

When the heat pump enters MODE1 for a period time(This time is controlled by a parameter[SG02], the default is 120min, the maximum is 120min.), the unit forced to exit the MODE1, enter the Normal mode and works in the setting mode(heating, hot water, etc.) until the unit turns off automatically.

When the heat pump enters the sleep mode, the anti-freeze protection is still effective in order to prevent the pipes and units getting frozen due to the low ambient temperature. That is, during the unit in sleep mode, when the ambient temperature and temperature of pipes are detected to be lower than the winter freeze protection condition, the heat pump will turn on and run with high energy efficiency frequency to produce heat, after the temperature of the water in the pipes is heated to a temperature that ensures safety and does not freeze, the heat pump exits the winter freeze protection and continues to keep the sleep mode, until the [SG02] is met or MODE 1 is exited.

Conditions for exiting MODE1:

Manual off/on in MODE1:

Manual turn off in MODE1 mode, the heat pump will exit MODE1 and enter the OFF state.

If manual turn on the unit again, then re-judge whether it is in MODE1, if it is judged to need to enter the MODE1, then directly into the MODE1, rather than turn on the unit

## **2. MODE 2: Solar Low Mode**

Only works when the heat pump is on. The heat pump enters the solar low mode, the main screen of the display shows the solar low mode.

1. The operating target temperature = The setting target temperature;
2. Don't allow to turn on electric heater in solar low mode;
3. The operating power of the heat pump is the parameter [SG03].

## **3. MODE 3: Solar Medium Mode**

Only works when the heat pump is on. The heat pump enters the solar medium mode, the main screen of the display shows the solar medium mode.

1. The operating target temperature = The setting target temperature;
2. Don't allow to turn on electric heater in this mode;
3. The operating power of the heat pump is the parameter [SG04].

#### 4. MODE 4: Solar High Mode

Only works when the heat pump is on. The heat pump enters the solar high mode, the main screen of the display shows solar high mode.

1. In heating mode: The operating target temperature = The setting target temperature + parameter [SG06]
2. In cooling mode: The operating target temperature = The setting target temperature - parameter [SG07]
3. In hot water mode, The operating target temperature = The setting target temperature + parameter [SG05]

#### Note:

When there is no hot water demand, the heat pump will automatically raise the target temperature of hot water to ensure that it can automatically switch to hot water mode to use the hot water tank storage heat during that time.

4. In Mode 4 mode, Whether to allow electric heater on can be selected by parameter.

If enable the electric heater in mode 4 mode, the electric heater will turn on immediately, which is to convert electric energy into thermal energy for storage during the shortest time when the sunlight is strongest.

#### Note:

Considering the safe operating range, in this mode the heat pump is limited by the curve of the maximum water temperature.

Note:

1. Compensation temperature for Mode 4:

There are four control options for automatic start/stop of heat pumps:

- H25=3 [Buffer tank temperature];
- H25=2 [Inlet water temperature];
- H25=0 [Outlet water temperature];
- H25=1 [Room temperature];

When H25=1, the temperature compensation in solar high mode only works for the outlet water temperature.

When H25=3/2/0, the temperature compensation in solar high mode works for the temperature set by H25 parameter.

When enable multi-zone control function and H25≠1, the temperature compensation in solar high mode works for the temperature set by H25 parameter.

2. The interval time for mode switching:

When the mode needs to be switched, the heat pump must run in the current mode for at least 10 minutes before switching to another mode.

Mode information on the display



## 12.4. Parameters

### 12.4.1. Parameter list

Code	Parameter	Setting range
SG01	SG Ready Application	0- Disabled 1- One potential-free contact 2- Two potential-free contacts
SG02	Block Time of Mode 1	0-120 min
SG03	Limited Power in Solar Low Mode 2	0-99,9 kW
SG04	Limited Power in Solar Medium Mode 3	0-99,9 kW
SG05	Additional Hot Water Temp. in Mode 4	0-25°C
SG06	Additional Heating Water Temp. in Mode 4	0-25°C
SG07	Additional Cooling Water Temp. in Mode 4	0-25°C
SG08	Turn On the Electric Heater Immediately in Mode 4	0-No/1-Yes

### 12.4.2. Parameter screen

- Press „Parameter”

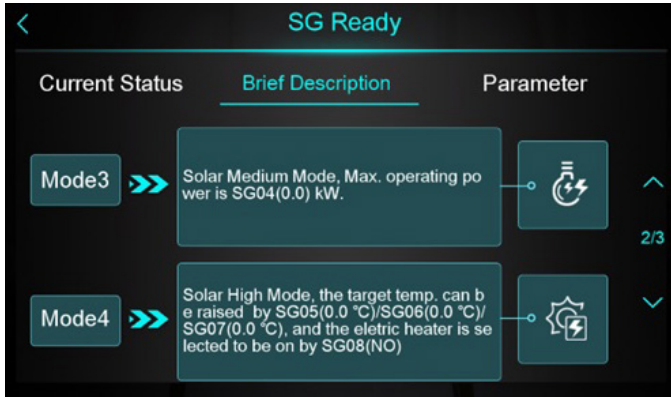

- Enter password: „22”

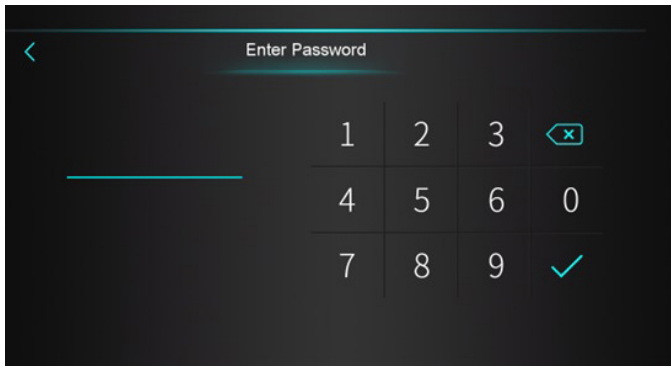

- Enter the parameter setting screen



### 12.4.3. Mode, temperature, and power programmer

- Press „Smart Grid”

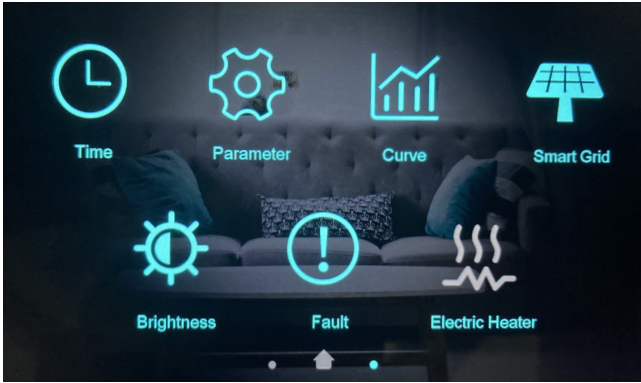

- Press „Mode&Temp.&Power Timer”

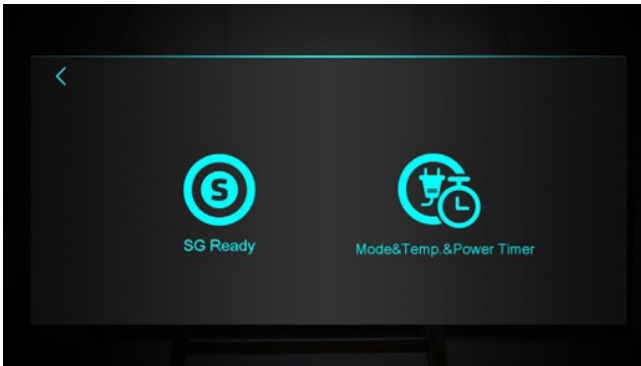

- The screen of the mode, temperature, and power programmer will be displayed

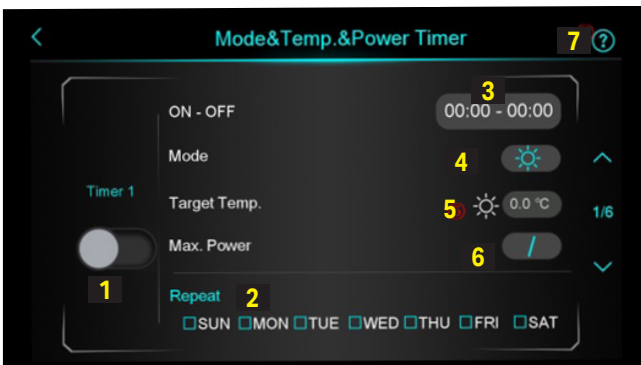



1	Enable the timer
2	Set timed date
3	Set timer time
4	Set target mode If you don't need to control mode, please choose disabled
5	Set target temperature
6	Set power limitation If you don't need to limite the power, please set "Max. Power" to 0
7	Click to enter the function introduction

- Function information screen

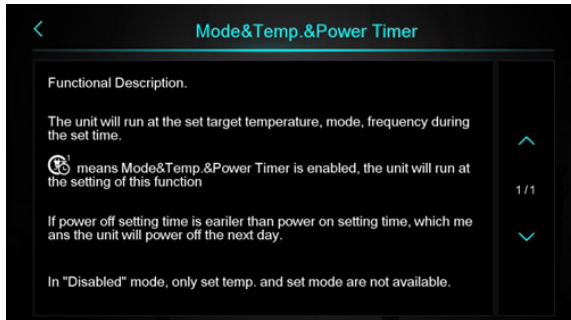

**Note:**

- After activating the function, the device will operate at the set temperature, mode, and frequency during the configured time.
- Icon  means that the function is enabled.
- Tryb nieaktywny



#### 12.4.4. Configuration of the timer function for on/off times.

The Timer function for on/off times and warm water circulation control allows you to program the operating time of the device and the circulator pump itself. The control panel enables you to set up to 6 time intervals and select the days of the week during which the functions should operate.

#### Example:

If you want the device to operate from Tuesday at 10:00 PM to Wednesday at 8:00 AM, you should follow these steps:

- 1). Set the on/off time to 22:00-8:00.
- 2). Activate Timer1 by moving the switch to the right.
- 3). Make sure to select the days on which you want this function to work. In this case, you would select Tuesday (Wt).

By configuring these settings, the device will automatically start working on Tuesday at 10:00 PM and stop on Wednesday at 8:00 AM. This function will be active only on the selected days (Tuesday).

Previous version of the timer function:

- You need to set two time intervals.

New version of the timer function:

- Setting up one time interval is sufficient

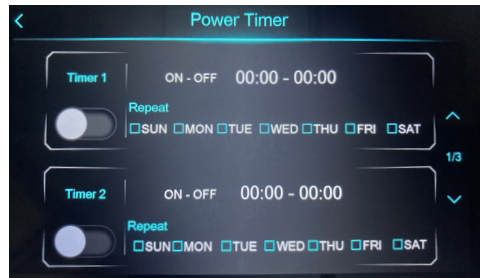

## 13. Add multi-zone control function

(ability to control temperature sensor/thermostat in various types of installations)

### 13.1. Application

13.1.1 Ogrzewanie/chłodzenie pomieszczeń + przygotowanie C.W.U.

No	Name	No	Name
1	Heat pump	12	Domestic hot water tank
2	Filter	12.1	Heat exchanger
3	Check valve	13	Check valve
4	Drain valve	14	Hot water circulation pump
5	Filling valve	15	Tap
6	Three-way valve	16	Buffer tank sensor
7	Buffer tank	17	DHW tank sensor
7.1	Air vent	18	Sensor at the outlet of zone 2
7.2	Drain valve	RAD1...n	Radiator 1...n
8	Zone 1 water pump	FHL1...n	Floor heating 1...n
9	Bypass valve	RT1	Thermostat for zone 1
10	Zone 2 mixing valve	RT2	Thermostat for zone 2
11	Zone 2 water pump		

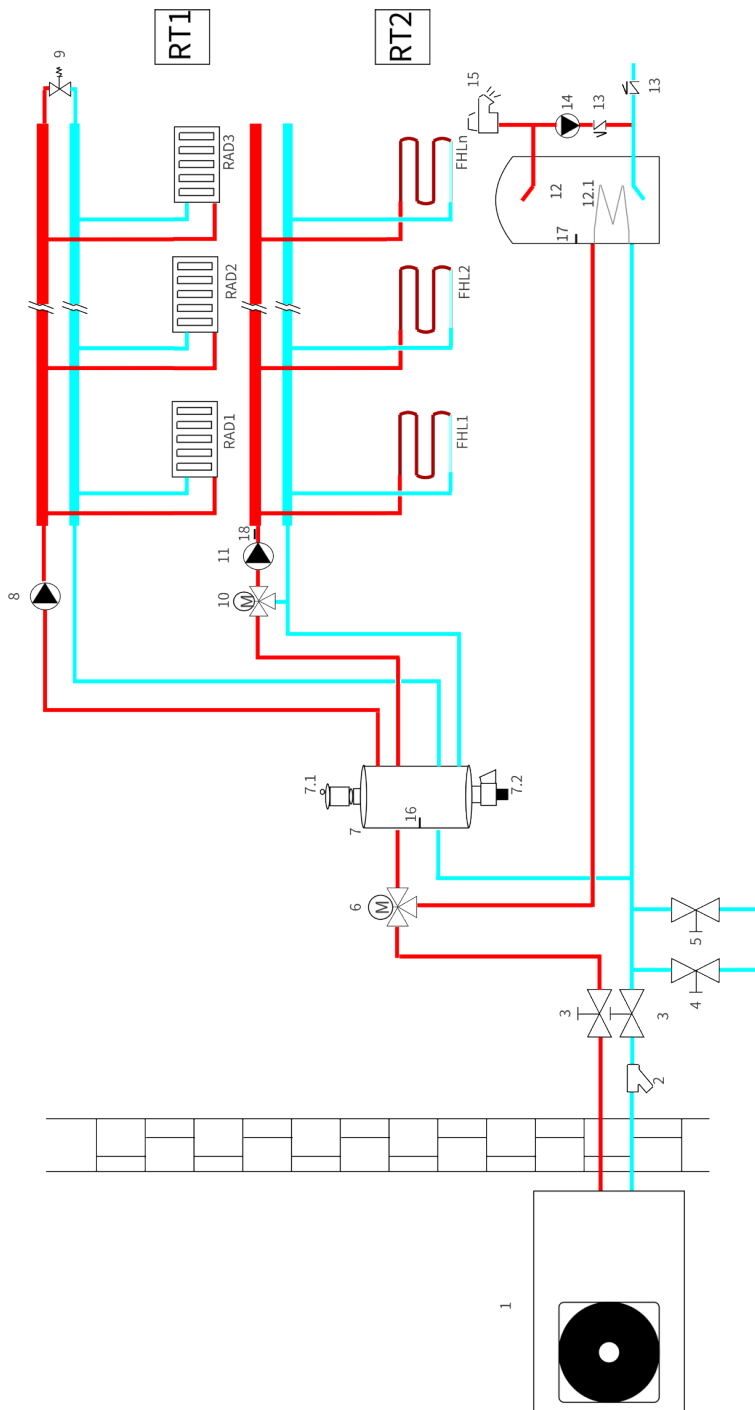

## 13.2. Zone control

### 13.2.1. Disabling zone control

If parameter Z01=None(0), the zone control function is inactive.

During this time, the zone control function will not be visible.

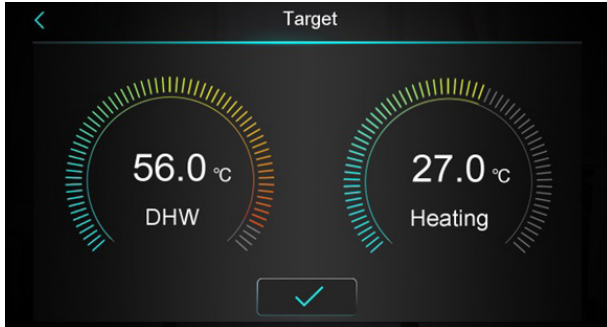

Click the Target option to enter the target temperature configuration interface.

Cooling mode:



Cooling Mode + Domestic Hot Water Preparation Mode:



Heating Mode:



### 13.2.2. Enabling Zone Control

If parameter Z01  $\neq$  0, the Zone Control function is active. Then, instead of the target heating temperature, the multi-zone control screen will be displayed as in the example below.

Heating Mode + Domestic Hot Water Preparation Mode:



### 13.2.3. The Zone Control Interface:

Click „” to access the Zone Control Interface:

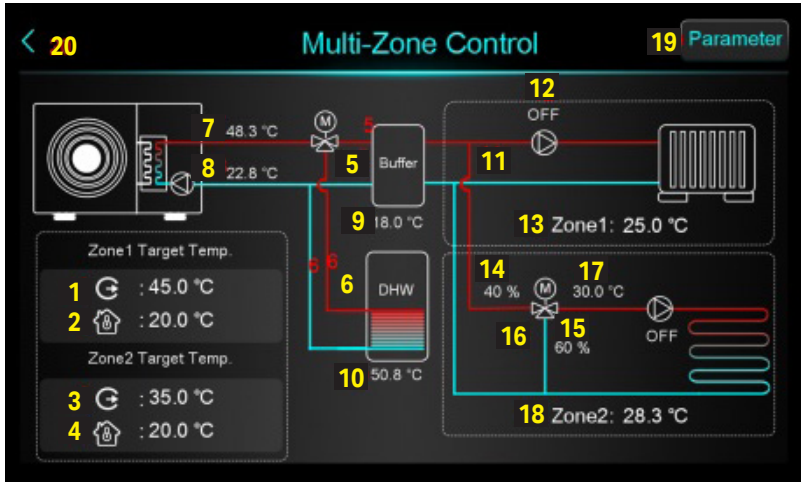

1	When Z16=0(Disable weather compensation curve in zone 1), display Z06 (Target outlet temperature in zone 1); When Z16=1(Enable weather compensation curve in zone 1), display target outlet water temperature after compensation.
2	Z02 - Room target temperature in zone 1.
3	When Z17=0(Disable weather compensation curve in zone 2), display Z07 (Target outlet temperature in zone 2); When Z17=1(Enable weather compensation curve in zone 2), display target outlet water temperature after compensation.
4	Z03 - Room target temperature in room 2,
5	This arrow is displayed when the heating mode is running.
6	This arrow is displayed when running hot water mode, high temperature disinfection mode.
7	Display outlet water temperature T02, when the water temperature sensor has fault, display -- °C/°F.

8	Display inlet water temperature T01, when the water temperature sensor has fault, display -- °C/°F.
9	When H25=buffer tank control, display buffer tank temperature T07, when the water temperature sensor has fault, display -- °C/°F; When H25≠buffer tank control, display --- °C/°F, and Buffer will become "Not used".
10	Display Tank temperature T08, when the water temperature sensor has fault, display -- °C/°F.
11	When zone 1 pump turns on, this group of arrows is displayed.
12	When zone 1 pump turns on, display "ON", otherwise display "OFF".
13	Display zone 1 room temperature, when the water temperature sensor has fault, display -- °C/°F. When Z01=4/5/6/7/8/9, it means the unit is connected to the passive switch thermostat or room thermostat, and the unit will just receives the signal, when the thermostat asks the unit to turn on, then here
14	Display the percentage of zone 2 mixing valve steps.
15	Display 100 - the percentage of zone 2 mixing valve steps. Steps of Point 14 +Steps of Point 15 = 100.
16	This group of arrows is displayed when the Zone 2 pump is turned on.
17	Presentation of water temperature for Zone 2. In the event of a sensor fault, -- °C/°F is displayed.
18	Display zone 2 room temperature, when the water temperature sensor has fault, display -- °C/°F. When Z01=4/5/6/7/8/9, it means the unit is connected to the passive switch thermostat or room thermostat, and the unit will just receives the signal, when the thermostat asks the unit to turn on, then here will show Zone2: Start, otherwise, it will show Zone2:Stop.
19	After clicking, enter password 22, will enter the multi-zone function parameter list.
20	Click to return the last screen.

### 13.3. Various Zone Options

#### 13.3.1 Activation of Zone 1 and Zone 2

After setting Z01=0 in the list of parameters for zone control on the interface of this function, the following screen will be displayed:

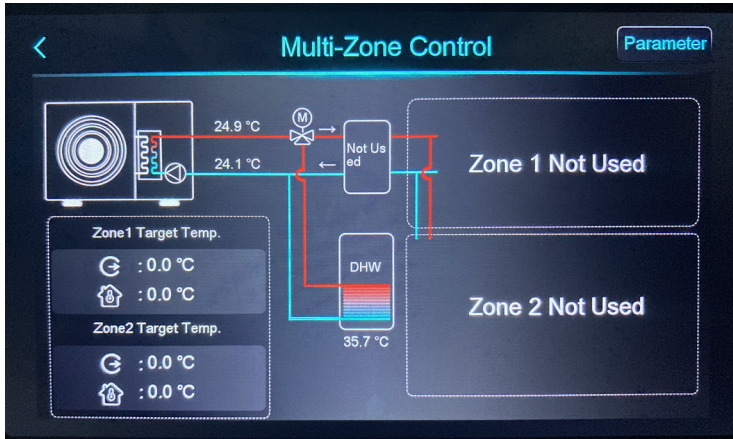

#### 13.3.2. Activating Zone 1

Setting Z01=1/4/7 means that Zone 2 is inactive.

Only Zone 1 is active.

The status of Zone 2 will be displayed as "Not used".

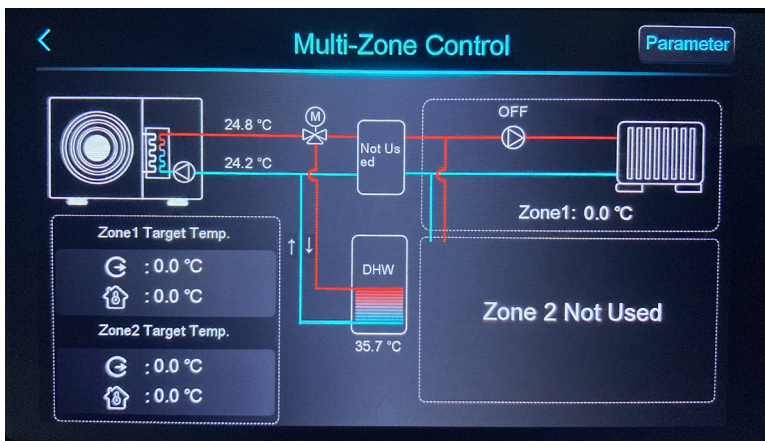



### 13.3.3. Activation of Zone 2

Setting Z01=2/5/8 means that Zone 1 is inactive.  
Only Zone 2 is active.  
The status of Zone 1 will be displayed as "Not used"

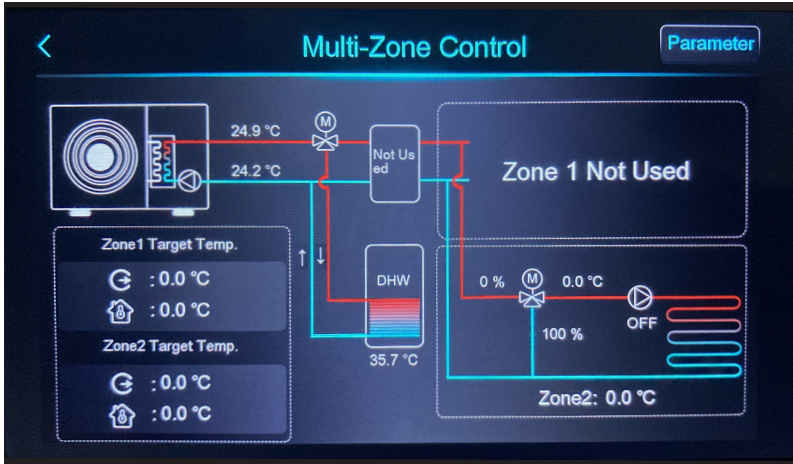

### 13.3.4. Activation of Zone 1 and Zone 2

Setting Z01=3/6/9 means that both Zone 1 and Zone 2 are active.  
Below is the screen displaying both active zones.

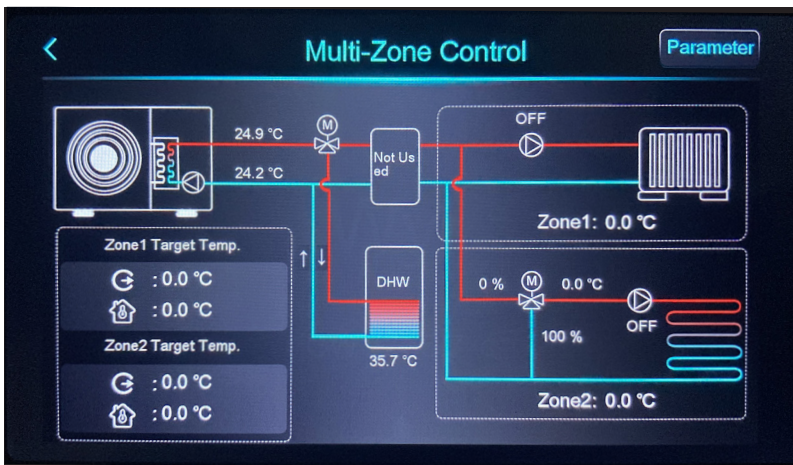

### 13.4. Setting the target temperature for Zone 1:

#### 13.4.1 Activating the temperature curve:

- 1) Click „“ to enter the target temperature for zone 1..

Here you can set the water outlet temperature for zone 1, the target room temperature for zone 1, and the temperature compensation value for zone 1.



- 2) Click on the "Zone 1 AT-WT Compensation" option to navigate to the temperature curve settings for zone 1

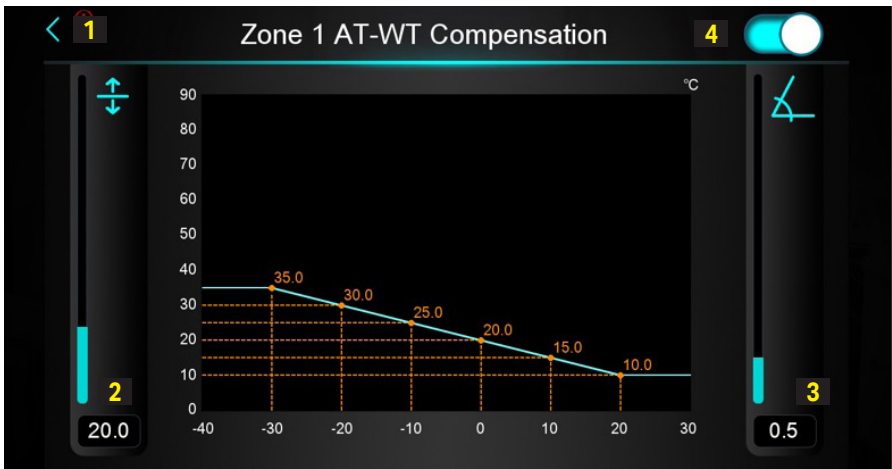

Description of individual screen elements:

1	Click to return to the previous interface.
2	Target temperature at an outside temperature of 0°C (0~85).
3	Slope of the temperature curve (0~3.5).
4	Button for activating temperature compensation.

**Note:**

- 1 – Temperature shift is the reference temperature value. The setpoint temperature value will be automatically adjusted.
- 2 – Formula for calculation: Adjusted temperature = - slope \* current AT + temperature shift.

In the case of presenting temperatures in Fahrenheit degrees, the following calculation formula will be automatically applied:

$$\text{Corrected Target Temperature} = - \text{Slope} * (\text{Current Temp.} - 32) + \text{Offset}$$

How to set up the temperature curve?

The temperature curve function relates to two parameters: slope and offset. To determine the slope and offset, linear regression is applied.

**Example:**

- we want to set the target temperature to 25°C for an external temperature of 10°C
- we want to set the target temperature to 30°C for an external temperature of 0°C
- we want to set the target temperature to 35°C for an external temperature of -10°C

Next, you should use this data to calculate the slope and offset. The slope is -0.5 and the offset is 30. In this case, you should set the slope to 0.5 and the offset to 30.

13.4.2. Disabling temperature compensation.

After disabling temperature compensation for zone 1, the status of the temperature curve will change to “Not used.”

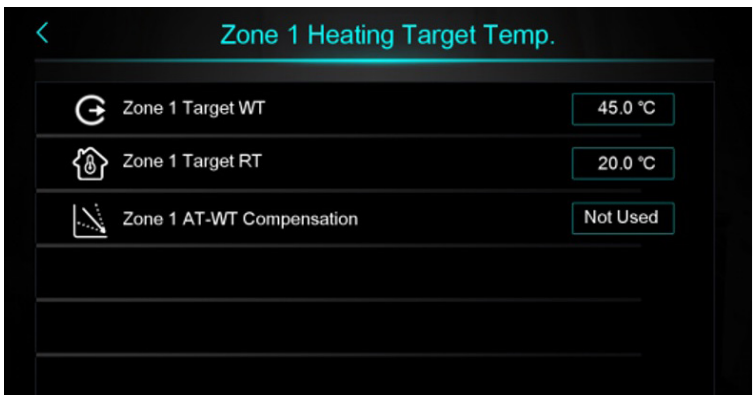

## 13.5. Setting the Target Temperature for Zone 2

### 13.5.1 Activating Temperature Curve

- 1) Click „“ to enter the target temperature for Zone 2.

Here you can set the water outlet temperature for Zone 2, the target room temperature for Zone 2, and the temperature compensation value for Zone 2.



- 2) Click the "Circuit 2 Weather Control" option to access the temperature curve settings for Zone 2.

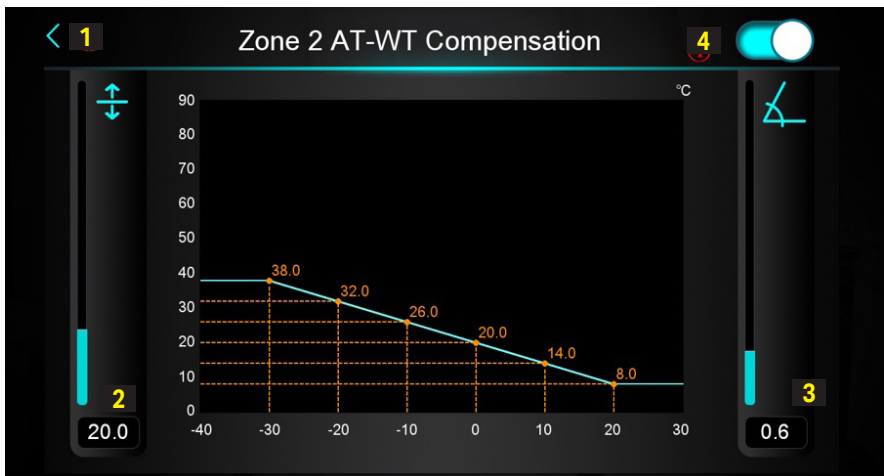

Description of individual screen elements:

1	Click to return to the previous interface.
2	Target temperature at an outside temperature of 0°C (0~85).
3	Slope of the temperature curve (0~3.5).
4	Button to activate temperature compensation.

**Note:**

1 – Temperature offset is a reference temperature value.

2 – Calculation formula: Corrected temperature = - slope \* current AT + offset.

In the case of temperature presentation in Fahrenheit degrees, the following calculation formula will be automatically applied: Corrected target temperature = - slope \* (current temp. - 32) + offset.

To set up the temperature curve: The temperature curve function involves two parameters: slope and offset. To determine the slope and offset, linear regression is used.

13.5.2. Disabling the temperature curve:

After deactivating temperature compensation for zone 2, the status of the temperature curve will change to “Not used.”



## 13.6. Setting temperature for zone control in cooling mode.

If Z01≠0 and the set mode is cooling / cooling + hot water preparation, click  to access the target temperature configuration interface:



## 13.7. Zone Control Function Parameters

### 13.7.1 Navigating to the list of parameters

1. Click „Parameter“.

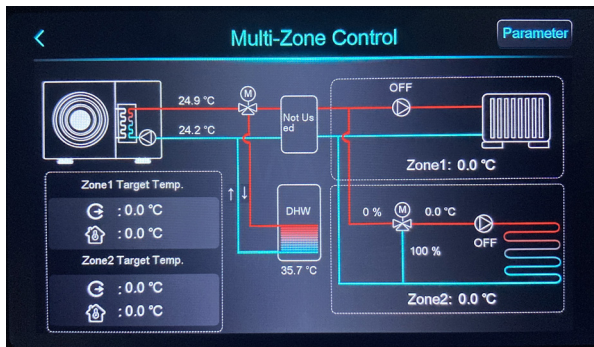

2. Enter password 22.

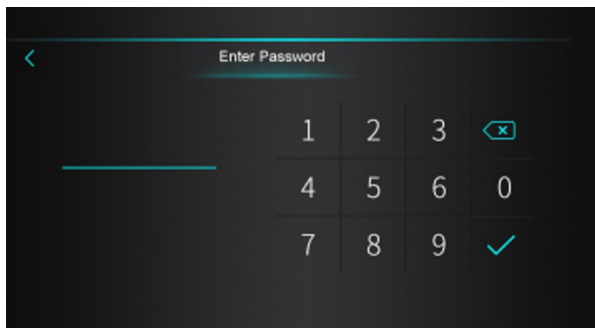

3. The list of parameters for the zone control function will be displayed.

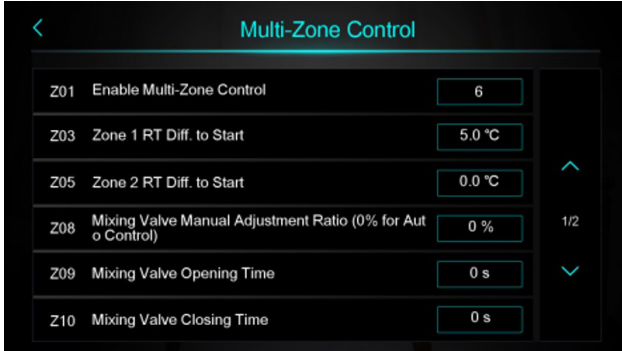

### 13.7.2. Degrees of the mixing valve

In heating mode:

The device will adjust the degrees of the mixing valve automatically. There is no need to set them manually.

## 13.8. Parameters

### Note:

S – means temperature sensor

T – means thermostat

P – means passive thermostat

RT – means room temperature

WT – means water temperature

Code	Parameter	Range
Z01	Activate zone control.	1- Zone 1-S 2- Zone 2-S 3- Zone 1&2-S 4- Zone 1-T 5- Zone 2-T 6- Zone 1&2-T 7- Zone 1-P 8- Zone 2-P 9- Zone 1&2-P
Z02	Target room temperature for Zone 1.	10-35 °C
Z03	Temperature difference for Zone 1 to start operation.	0-10 °C

<b>Code</b>	<b>Parameter</b>	<b>Range</b>
Z04	Target room temperature for Zone 2	10-35 °C
Z05	Temperature difference for Zone 2 to start working	0-10 °C
Z06	Target WT at the outlet for Zone 1.	R10-R11 °C
Z04	Target RT for Zone 2	10-35 °C
Z05	Temperature difference for zone 2 to start operation.	0-10 °C
Z06	Target WT at the outlet for zone 1.	R10-R11 °C
Z07	Target WT at the outlet for zone 2.	R10-Z15 °C
Z08	Coefficient of manual regulation of the mixing valve (0% for automatic control)	0-100%
Z09	Mixing valve opening time	0-2000 s
Z10	Mixing valve closing time	0-2000 s
Z11	Mixing valve proportional (P) control	0-10.0
Z12	Mixing valve integral (I) control	0-10.0
Z13	Mixing valve PID control duration	1-20 min 1-20 min
Z14	Mixing valve degrees in cooling mode	0-100%
Z15	Maximum target water temperature for zone 2	0-99 °C
Z16	Activate temperature compensation AT for zone 1.	0-No 1-Yes
Z17	Activate temperature compensation AT for zone 2.	0-No 1-Yes
Z19	Temperature difference at low water temperature with- out the pump activated.	0 °C ~25 °C
Z20	Activate water pump for zone 1 in cooling mode.	0-No/1-Yes



## 14. Muting

The mute function affects the device's operation by reducing the heat pump's power (fan speed) and providing quieter operation. You can set the activation and deactivation times for the function, and also adjust the buttons below the set times to enable/disable the function.



## 15. Curve

The curve function records water temperature at the inlet and outlet. Temperature data is collected every five minutes, and 12 sets of temperature data are saved every hour. The timing of measurements is based on the latest recorded data. If there's a power interruption lasting less than 1 hour, data for that period won't be saved.

Only the state curve during device activation is recorded; the state curve during device deactivation is not saved. The value on the x-axis indicates the time from a point on the curve to the current time point. The leftmost point on the first page (with a value of 0 on the x-axis) represents the latest temperature record. The temperature curve is stored thanks to a memory function that operates even when the power is off.

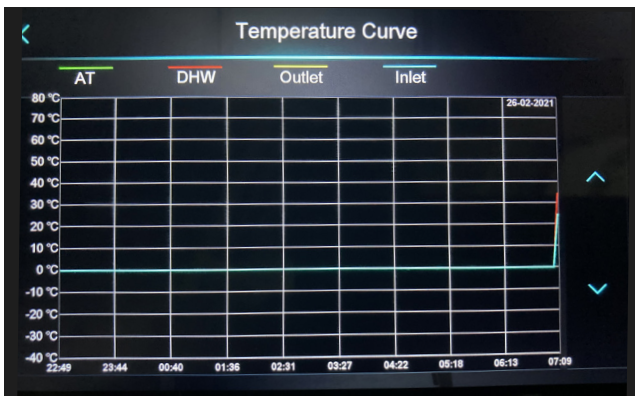

## 16. Failure

Clicking the "Failure" icon will open a list of error history as shown below. Only a qualified and authorized installer or service technician can service the device. To do so, please contact the distributor or manufacturer.

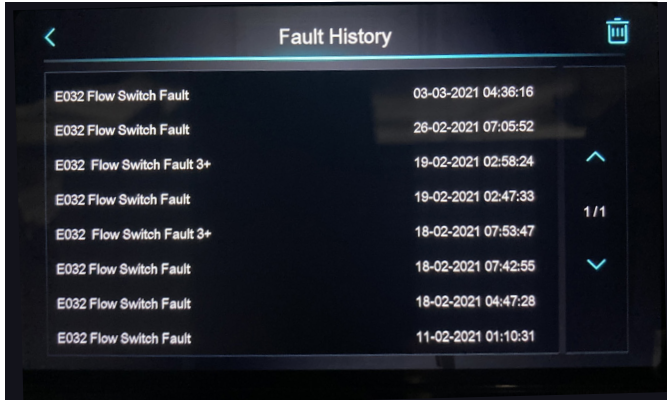

The screenshot shows a 'Fault History' screen with a list of error events. The screen has a dark background with light text. At the top, there is a title 'Fault History' and a trash icon on the right. A list of events follows, each with a description, a timestamp, and a status icon. The status icons are blue chevrons pointing up or down. A '1 / 1' indicator is visible on the right side of the list.

Event Description	Timestamp	Status
E032 Flow Switch Fault	03-03-2021 04:36:16	
E032 Flow Switch Fault	26-02-2021 07:05:52	
E032 Flow Switch Fault 3+	19-02-2021 02:58:24	Up Arrow
E032 Flow Switch Fault	19-02-2021 02:47:33	
E032 Flow Switch Fault 3+	18-02-2021 07:53:47	1 / 1
E032 Flow Switch Fault	18-02-2021 07:42:55	Down Arrow
E032 Flow Switch Fault	18-02-2021 04:47:28	
E032 Flow Switch Fault	11-02-2021 01:10:31	

# Notes

Thank you for choosing our product.  
For more information, please visit our website: <https://kaisai.com/>



**WE  
CARE  
ABOUT  
AIR**

kaisai.com